



# Geosub 2 Pump & Controller

Installation and Operation Manual





## Table of Contents

<b>Section 1: System Description</b> .....	<b>4</b>
<b>Section 2: System Installation</b> .....	<b>6</b>
<b>Section 3: System Operation</b> .....	<b>10</b>
<b>Section 4: System Maintenance</b> .....	<b>17</b>
<b>Section 5: System Troubleshooting</b> .....	<b>26</b>
<b>Section 6: System Specifications</b> .....	<b>28</b>
<b>Section 7: Replacement Parts List</b> .....	<b>31</b>
<b>EC Declaration of Conformity</b> .....	<b>36</b>
<b>The Warranty</b> .....	<b>37</b>

## DOCUMENTATION CONVENTIONS

This document uses the following conventions to present information:



### WARNING

An exclamation point icon indicates a **WARNING** of a situation or condition that could lead to personal injury or death. You should not proceed until you read and thoroughly understand the **WARNING** message.



### CAUTION

A raised hand icon indicates **CAUTION** information that relates to a situation or condition that could lead to equipment malfunction or damage. You should not proceed until you read and thoroughly understand the **CAUTION** message.



### NOTE

A note icon indicates **NOTE** information. Notes provide additional or supplementary information about an activity or concept.



## NOTICES

In order to ensure that your Geosub 2 Controller has a long service life and operates properly, adhere to the cautions below and read this manual before use.

Disconnect from power source when not in use.

Controller power input source must not exceed maximum ratings.

Controller must be wired to a negative ground system.

Controller may not operate properly with excess wiring not supplied by manufacturer.

Avoid spraying fluid directly at controller.

Never submerge controller.

Avoid pulling on wires to unplug controller wiring.

Avoid using controller with obvious physical damage.

To prevent controller damage, avoid dropping controller.



The Geosub 2 Pump and Geosub 2 Controller cannot be made dangerous or unsafe as a result of failure due to EMC interference.



Do not operate this equipment if it has visible signs of significant physical damage other than normal wear and tear.

### Notice for consumers in Europe:

This symbol indicates that this product is to be collected separately.

The following apply only to users in European countries:

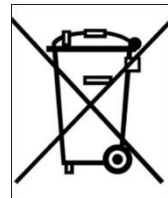

- This product is designated for separate collection at an appropriate collection point. Do not dispose of as household waste.
- For more information, contact the seller or the local authorities in charge of waste management.

## Section 1: System Description

### Watt Controller Function and Theory

This Geosub 2 Controller is designed specifically for use with Geotech's Geosub 2 Pump. It provides a safe conditioned variable DC output power from an AC power source. Built-in sensing gives the operator accurate and precise control over the pump during sampling events. Efficient operation allows for extended field operation using portable AC generator equipment such as a gasoline-powered generator. An average 1000-Watt gasoline powered generator with 1 gallon of gasoline can operate the Geosub 2 Controller and Geosub 2 sampling pump at full power for up to 18 hours.



Be sure to read and understand your portable generator User Manual for proper installation operation, and earth-grounding instructions.

An easy to use programmable user interface with bright display offers precise control over water flow during ground water sampling events. Site-specific settings can easily be stored and recalled for repeatable efficiency during sampling events. Rugged construction and portability make connecting, installation and setup a breeze. The controller also includes a user activated dry run protection feature.

### Pump Function and Theory

Geotech's Geosub 2 Pump is a fully submersible environmental pump designed specifically for use in ground water sampling. All wetted parts are made from high quality inert materials so sample integrity is not affected during sampling. The Geosub 2 flow rate can be adjusted to change from well purge flow rates to low flow sampling rates. Figure 1-1 contains a graph for the flow rates and operating depths.

### Drop Tube Intake System

Geotech's optional Drop Tube Intake System allows you to easily relocate the pump intake well beyond the depth limitations of the pump. As long as the pump remains submerged, you can effectively and economically low flow a sample from a deeper point within the well's screened section. See Figure 2-1.

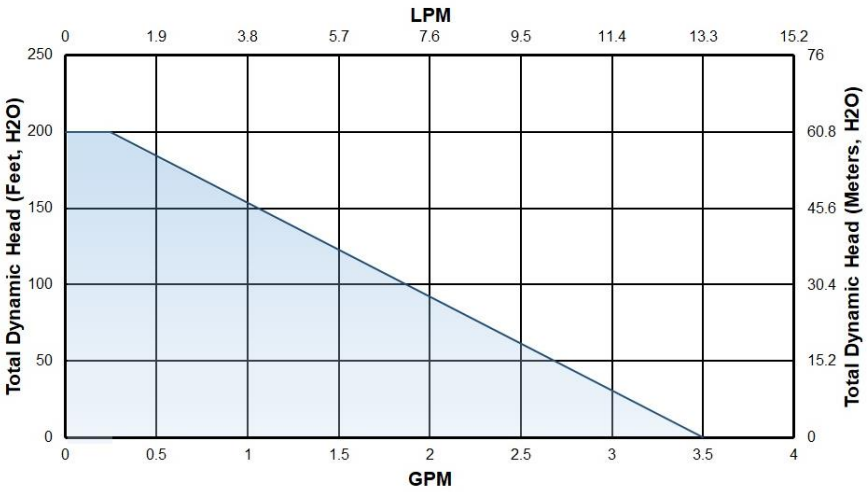

**Figure 1-1: Pump Performance Chart**

### Dry Run Feature Operation and Theory



The Dry Run pump protection feature operates by measuring the output current level and comparing it to a user enterable set point. Many factors can influence the pump current draw, including head pressure, length of tubing, and length of cable. Under all conditions, one thing remains the same: While pumping water, the pump draws higher current from the controller than when it is out of water and running dry regardless of other variables.





Dry Run is intended for use in situations where flow rates are above .1 GPM (.38 LPM). Results using Dry Run with lower flow rate are un-reliable.

### Pump Speed Control Operation and Theory

Pump speed control is achieved by pressing the up or down button during run time. The number can be adjusted from 1 to 255 in increments of one unit. The

adjustments can be made one at a time by pressing the  or  button once

or can be changed rapidly by holding the  or  button. This number is representative of power output. Most conditions do not allow for the full 1 to 255 point range of use. At the upper end of the scale, the controller automatically prevents the user from overpowering a pump. The controller indicates when max power has been reached and prevents the user from increasing the output further.

In most cases, the usable range of control will be a 100 point window somewhere within the 1 to 255 point range. In general, the longer the cable being used the higher the speed set point and vice versa. Other application specific conditions such as head pressure and tubing size will also affect the speed set point window of operation.



When adjusting the speed at the lower end of the 1 to 255 point scale, the pump may shut down. This fault condition is most obvious when a system has high flow, low pressure, and long cable.

```
PUMPING WELL #nn
nnn DR ON nn
```

OR

```
PUMPING WELL #nn
nnn DR OFF nn
```

Where #nn = Well #  
nnn = Pump speed  
nn = Time to reset dry well in minutes  
DR = Dry Run setting (ON/OFF)

### Minor Adjustments to Flow Rate

Small increments to flow rate can be made by raising or lowering the height of the sampling tube. If the sample rate is too low or too high, adjust the pump speed on the controller, and then adjust the height of the discharge tube.

- If the flow rate is too high, raise the discharge tubing.
- If the flow rate is too low, lower the discharge tubing.

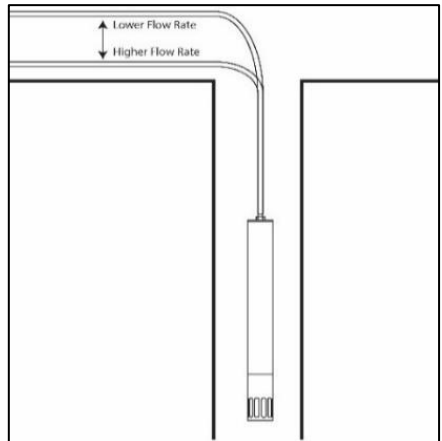

Figure 1-2: Minor Adjustments to Flow Rate



## Section 2: System Installation



### READ BEFORE PROCEEDING ANY FURTHER



The Geosub 2 Controller operates on high voltages supplied by a portable generator or grid-supplied main power. Care must be taken at all times to avoid electrical shock. Do not subject the Geosub 2 Controller to contact with water. A grounding rod or stake driven directly into moist earth must be installed and electrically connected if using a portable generator larger than 2000 Watts.

The Geosub 2 Controller operation should be performed only by qualified persons. Reading this manual is essential for operating this equipment safely. If, after reading this manual, you are still unsure about the operation of this equipment contact Geotech for further information and training.

The Geosub 2 Controller stores energy for short periods even after power has been removed. The Geosub 2 Controller has no field serviceable components and should never be opened by an unqualified person.

The Geosub 2 Controller has been specifically designed for use with Geotech's Geosub 2 Pump ONLY! Care must be taken when operating any equipment that operates on main voltage. Contact Geotech for service or repair. (See *Section 5, System Troubleshooting*, for common fault conditions and suggestions on how to correct issues).



Verify intended power source matches the model supply specifications of the Geosub 2 Controller in use. Geosub 2 Controllers are available in 120VAC and 230VAC 50/60HZ models and must be powered accordingly.



Damage will result if controllers are connected to incorrect input power supply. Once input power source has been verified, connect input power cable to the Geosub 2 Controller, and then connect cable to power source, i.e. portable generator or main grid power.

Connect input power cable. The display will light up, and after a short startup sequence is executed, a message will display indicating the controller status.

Attach the pump to the controller using factory-installed connectors on both the Geosub 2 Controller and pump cable. Use of any other connectors or method of attaching pump to controller will cause shock and or fire hazard.

When the status display shows, “Main Menu” proceed to *Section 3: System Operation*. If display is blank, shows a fault or error condition, proceed to *Section 5: System Trouble Shooting*.

### **Drop Tube Intake Assembly Installation and Operation**

The optional Drop Tube Intake Assembly is designed to allow you to relocate the Geosub 2 Pump intake to a deeper screened part of the well. The Geosub 2 Pump can either be built with a Drop Tube Intake and the necessary tubing length attached, or the Drop Tube Intake Assembly parts can be added to an existing pump at a later time. An example of all Drop Tube Intake parts can be found in *Section 7: Replacement Parts List*.

When using a Drop Tube Intake with your Geosub 2 Pump, the pump must be placed below the static water line, as shown in Figure 2-1. Using a Drop Tube Intake can keep the pump at an optimum depth to maximize performance and the assembly is easily adaptable in the field.



Drop Tube tubing lengths are custom to each well. When using or re-using poly tubing, it is suggested that small hose clamps be attached at the two hose barbs to prevent the accidental detachment of the drop tube assembly within the well.

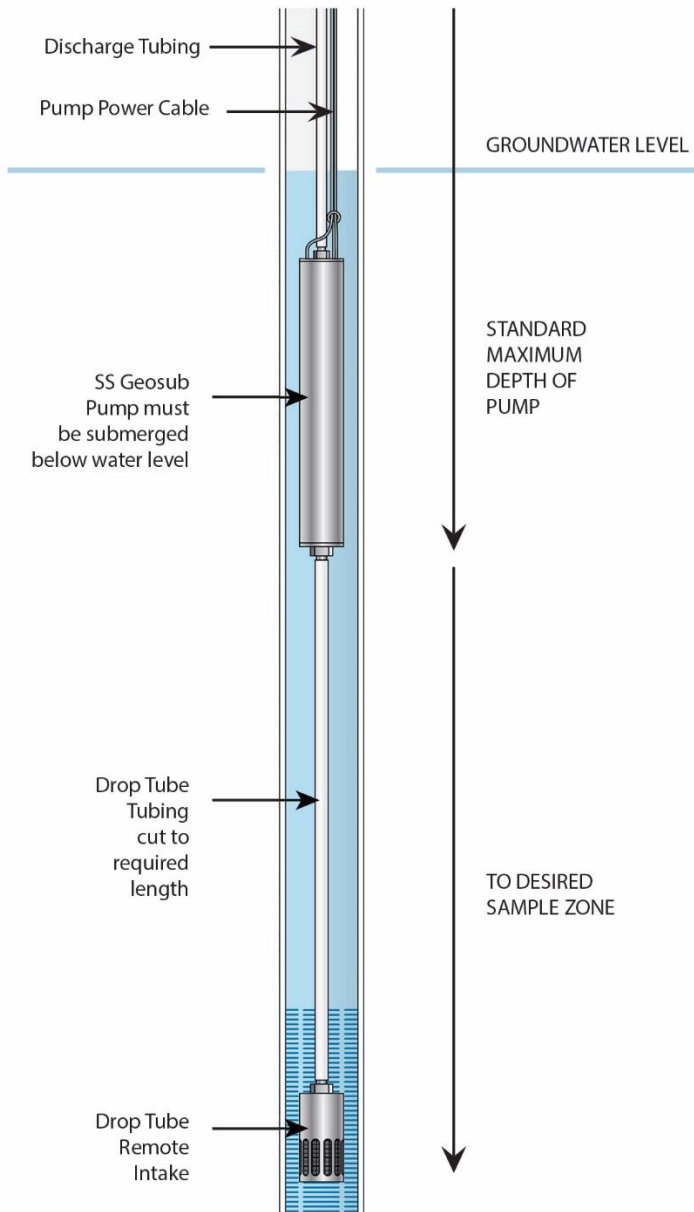

**Figure 2-1:** Geosub 2 Pump with Drop Tube Assembly in well

## Section 3: System Operation



When disconnecting power, it may take up to 2 minutes for complete shutdown.

### Key Pad Description:



This arrow is used to configure well option, raise the speed of the pump, and adjust settings in the program.



This arrow is used to lower pump speed and adjust other settings of the program.



This button will return you to the MAIN MENU from anywhere in the program.



This button is used to start the pump, confirm selections, and advance to the next section of the program.

### Basic Operation



- Plug power cord into controller.
- Plug power cord into AC supply outlet.
- Wait for initialization sequence to complete.
- From the MAIN MENU:

- Press  to start the pump with the default settings.

```
Rt=START      #nn  
U=SETUP      D=WELL
```

- Wait for soft start sequence to complete.

```
STARTING      #nn  
PLEASE WAIT
```

- Press the  or  buttons to adjust pump speed to achieve desired flow rate.
- Pump water at desired pump speed.

- Press  to stop and return to the MAIN MENU.

### Dry Run and Save Instructions



- Plug power cord into controller.
- Plug power cord into AC supply outlet.
- Wait for initialization sequence to complete.
- From the MAIN MENU:

- Press  to start the pump with the default settings.

```
Rt=START      #nn
U=SETUP      D=WELL
```

- Wait for soft start sequence to complete.

```
STARTING #nn
PLEASE WAIT
```

- Press  or  buttons to adjust pump speed to desired point.



```
PUMPING WELL #nn
nnn DR ON nn
```

- Press  to toggle Dry Run (DR) ON or OFF.

OR



```
PUMPING WELL #nn
nnn DR OFF nn
```

- Hold down the  button for 3 seconds to enter the Dry Run Reset Time Change menu and Well Save menu.

- Press  or  buttons to change reset from dry run time between 1 and 59 minutes.

```
SET DR DELAY
MINUTES = nn
```

- Press  to advance to Well # Write menu.

- Press  or  buttons to choose the well number in which you would like to save the new parameters in (up to 80 unique wells can be saved).

```
SAVE TO WELL
# = nn
```

- Confirm overwrite by pressing the  button.

```
OVERWRITE WELL
#nn?      (Rt=YES)
```

- Cancel overwrite by pressing the  button.
- Observe desired settings are displayed in the runtime display screen.



### Loading Saved Well

- Plug power cord into controller.
- Plug power cord into AC supply outlet.
- Wait for initialization sequence to complete.



```
Rt=Start      #nn
U=Setup      D=Well
```

- From MAIN MENU, press  to enter Load Well menu.

```
SELECT WELL   #nn
nnn DR OFF   nn
```

- Press  or  to select the well number and pre-set the parameters you would like to start pumping from.

```
WELL #nn
LOADED
```

- Press  to load selected well parameters.
- To cancel selection at any time, press .

```
NEW WELL
NOT LOADED!
```

- Press  to start pump with loaded well settings.





Loading Well #0 will load the default start-up configuration.

## Customize Well Settings

- Plug power cord into controller.
- Plug power cord into AC supply outlet.
- Wait for initialization sequence to complete.

- From MAIN MENU, press  to go to Well Setup menus.

```
Rt=Start      #nn
U=Setup      D=Well
```

- Press  or  to select the desired pump speed setting. Speed can be set from 20 – 200.

```
SET SPEED
nnn
```



- Press .

- To Toggle  OR .

```
SET DRY RUN
ENABLE = OFF
```



```
SET DRY RUN
ENABLE = ON
```

- Press .

- Press  or  to select how long the controller waits to start pumping again after dry run protection has been activated.

```
SET DR DELAY
MINUTES = nn
```

- Press  to save.

- Press  or  to select the well number in which to save these parameters in.

```
SAVE TO WELL
# = nn
```

- Press .
- You will now be returned to the MAIN MENU screen.

```
OVERWRITE WELL
# nn? (Rt=YES)
```

- From here, you can press the  button to begin pumping at the settings just entered.

## Display Descriptions

- MAIN MENU. Press  button to start the pump with the default settings.

```
Rt=Start      #nn
U=Setup       D=Well
```

- This message is shown after pressing the  button from the MAIN MENU.

```
STARTING      #nn
PLEASE WAIT
```

- This message is shown after pressing the  button in the MAIN MENU.

```
SELECT WELL   #nn
nnn DR OFF   nn
```

- This message is shown after pressing  to choose to load well # nn information.

```
WELL #nn
LOADED
```

- This is the run time message shown during normal operation:

```
PUMPING WELL #nn
nnn DR ON   nn
```

OR

```
PUMPING WELL #nn
nnn DR OFF   nn
```

- This message is shown if during soft start no pump is detected. There are various reasons for this to happen.

```
NO PUMP DETECTED
ATTACH PUMP
```

- Check to see if the connector is secure and that the cable is not broken.

- This message shows if the pump starts running before it should, or if there is a short circuit in the cable.

```
PUMP FAULT
DETECTED!
```

- The following messages are shown during runtime if the pump speed set point is raised to an overload position or lowered

```
PUMPING WELL #nn
- AT MAX POWER -
```



to a minimum point to maintain proper flow.

- The controller will automatically detect when max or minimum output has been reached and prevent the user from increasing or decreasing the output further.

```
PUMPING WELL #nn  
- AT MIN POWER -
```

- This message is shown during setup for adjusting the time the controller waits to reset after a dry run fault has been detected.

```
SET DR DELAY  
MINUTES = nn
```

- This message displays when an entry has been changed but not saved to controllers' memory for recall.

```
NEW ENTRIES  
NOT SAVED!
```

- This message is shown when the pump is no longer submerged in water during normal run time operation mm:ss indicates the time left in minutes:seconds before pumping is restarted. If the pump is still not submerged, the controller will restart the counter and return to this message.

```
DRY RUN DELAY  
PUMPING IN mm:ss
```

- This message is shown if the Dry Run counter has been manually overridden or when the operator has chosen to exit any runtime menu and is returning to the Main Menu.

```
RESETTING PUMP  
STANDBY
```

- This message is shown when there is a short circuit fault on the controller output.

```
OUTPUT FAULT  
OVER CURRENT
```

- Check the cable and pump carefully for any damage that may have occurred.
- Refer to *Section 5: System Troubleshooting*.

- This menu lets you choose in which well # to save the new parameters.

```
SAVE TO WELL  
# = nn
```

- This menu asks you to confirm your choice to overwrite information currently stored in well # nn.

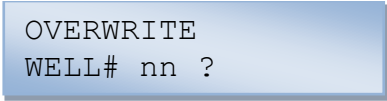

OVERWRITE  
WELL# nn ?

- May indicate major system fault. Disconnect power and allow controller to reset.



INVALID  
MODE

- If message should return, contact the Geotech service department.

## Section 4: System Maintenance



All of the procedures called out within this section are provided by the Geotech Service Department. Contact your nearest Sales Representative to have your Geosub 2 Pump and Controller professionally inspected and serviced.

### Controller:

Clean the controller as needed with mild soap and water on a cloth. Do not use abrasive cleaners or solvents. Do not spray with water or any other liquid or pressured solvents. Use an air source to blow water out of all cable connections as needed.

### Pump:

Clean the pump between sampling events using detergent and water. Cleaning the pump between uses is important to keep the impeller from getting stuck in place, making it impossible to pump water. Fine grit and particulate matter can cause threads and tight fitting parts to become extremely difficult to disassemble if left to dry in the pump after use. The pump can be disassembled completely for decontamination and cleaning.

Regularly check the conditions of the pump's o-rings.

There is one o-ring sealing the outer housing to the top cap, four o-rings sealing the inner housing to the top cap and motor, one o-ring sealing the motor cavity connector, and two captured o-rings sealing the wire lead through the top cap (remove socket head cap screws to access). Damaged o-rings should be promptly replaced before next use.



The Geosub 2 Pump must be thoroughly cleaned and dried between uses, especially prior to storage. Failure to thoroughly clean and dry the pump may result in corrosion and permanent damage to the equipment, making the pump unusable.

**Contact your Geotech Sales Representative for Replacement Parts covered in this manual.**

### Maintaining and Cleaning the Screened Intake

For optimal pump performance, it is recommended that the Screened Intake on the Geosub 2 Pump be regularly cleaned. If the pump is being consistently used in particle-heavy liquids, it is best to clean the intake after each use. Allowing mud or sand to dry and build up on the screen intake will result in decreased pump performance.

Tools needed:

- Flathead screwdriver, small
- Pick or hook tool

Power down and disconnect the pump from the controller, drain residual liquid. Work on a solid surface where no parts can fall out of sight.

1. Use a flathead screwdriver to remove the snap ring from its seat; there is a relief on the outer edge of the snap ring where the flathead can gain leverage without damaging the retaining disc.
2. Use a pick or hook tool along the outside of the retaining disc to dislodge from its seat.
3. Use a pick or hook tool on the inside of the screened mesh and gently pull down and out of the housing.



DO NOT PUSH OR DENT THE SCREEN, DOING SO WILL RENDER THE SCREEN DEFECTIVE

4. Rinse all components, including slots on outer housing, in clean water. Heavy buildup should be soaked and released with a wire brush. Assemble in reverse order, ensuring that the screen intake is in good condition and that all components fit securely.

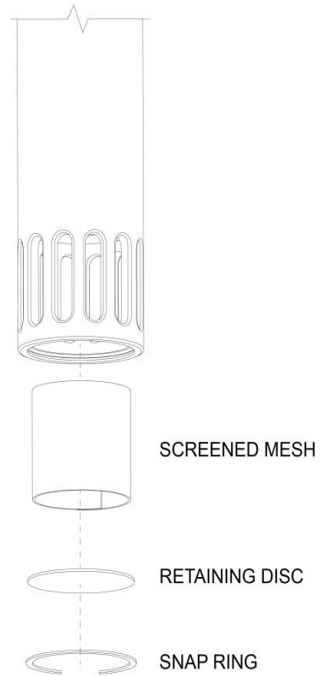

**Figure 4-1: Screened Intake**

This maintenance should also be performed on the Geosub 2 pumps equipped with a drop tube intake.

## Compression connection

The Geosub 2 will come from Geotech with a permanent potted connection. A compression connection will be used when replacement/repair is required.

Reference *Section 7: Replacement Parts List*, and Figure 7-1 and Figure 7-2 for part numbers.

To replace female connector on reel end:

1. Cut and remove existing connector and any damaged cable.
2. Measure and mark 12" from the end of the Geosub 2 cable.



3. Using an X-acto blade (or similar blade), score the cable between safety cable and conductors, on each side of the safety cable.
  - Do not cut or damage conductors or safety cable.



4. Flip cable over and repeat, scoring each side of cable.

5. Score cable until cable neatly separates.

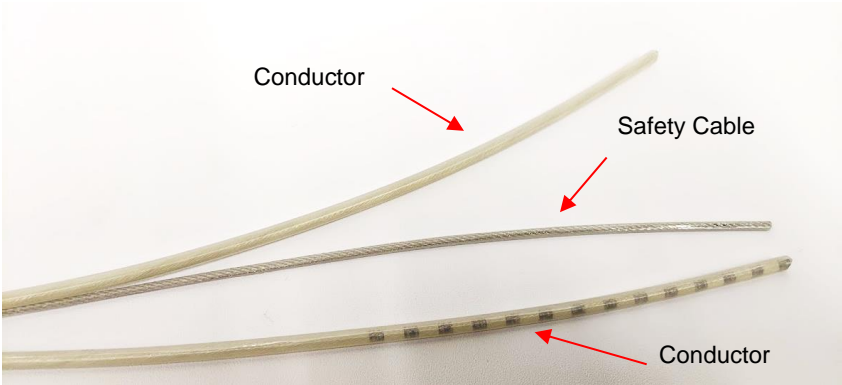

6. Pull conductor wires through the eye bolt then through the top cap.
- Leave 3.5" of cable (cut ends) extending past the bottom top cap.
  - Run conductors through the 3.3mm x 2.4mm Buna o-rings and place o-rings in the grooves in the top cap.



7. Pull conductor wires through the bottom cap.
  - Ensure the bottom cap screw hole are aligned with the screw holes on the top cap.

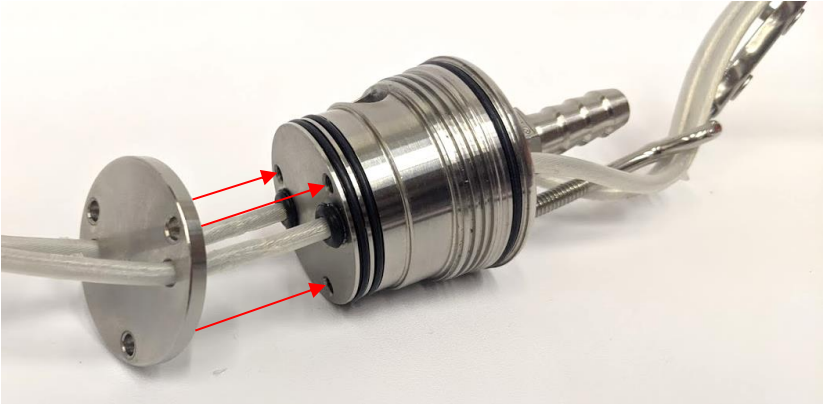

8. Secure bottom cap in place using the three (3) 6-32 x 3/8 screws.
9. Run the safety cable through the eye bolt, back up through the cable clamp and secure.
10. Place the connector nut, with threads facing the cut side, over the wires.
11. Place wire seal over the wires (ensure the correct orientation of the wires)
12. Pull wires through the connector housing.
  - The black marked wire goes through the raised side of the housing.
  - The unmarked wire goes through the pocket side of the housing.

Raised Side



Pocket Side

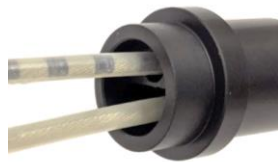

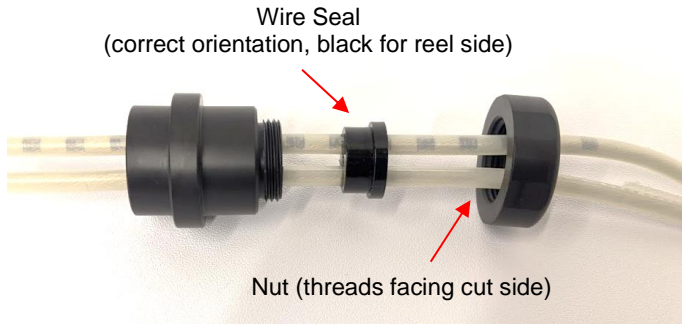

13. Strip wires 3/16" using the 12AWG setting on wire strippers and tin wires.



14. Solder wires to female pin to the stripped wires.
- Do not over-solder the wires.
  - If the pins are over-soldered, they will not fit into the housing.





15. Pull wires back through housing so that the pins are slightly below the step.
  - If a small press is available, use it to press the connectors in, otherwise they will need to be pulled through. A solid solder connection will ensure this can be done.
  - The pins need to be below the step of the housing.



16. Push wire seal into housing cavity.
17. Tighten nut to compress the grommet.
  - If needed, lubricate the wire seal with deionized water or a lubricant that is approved for your application prior to tightening compression nut.



To replace male connector on motor end:

1. Cut and remove existing connector and any damaged wire.
2. Place nut, with threads facing the cut end, over the wires.
3. Place wire seal over the wires (ensure the correct orientation of the wires)
  - The wire seal will be blue on the motor side.
4. Pull wires through housing.
  - The black wires goes through the low step side of the housing.
  - The red wire goes through the other side of the housing.



5. Strip wires 3/16" using 14AWG wire strippers then tin the wires.



6. Solder male pin connectors to wires.
  - Do not over-solder pins.
  - If pins are over-soldered, they will not fit into the housing.



7. Pull wires back through the housing so that the pin is slightly below the tall step of the housing.
  - If a small press is available, use it to press the connectors in, otherwise they will need to be pulled through. A solid solder connection will ensure this can be done.
  - The pins should be below flush with the housing.
8. Push wire seal into the housing cavity.
9. Tighten on the compression nut to compress the wire seal.
  - If needed, lubricate the wire seal with deionized water or a lubricant that is approved for your application prior to tightening compression nut.
10. Place o-ring in groove, lubricate if needed.

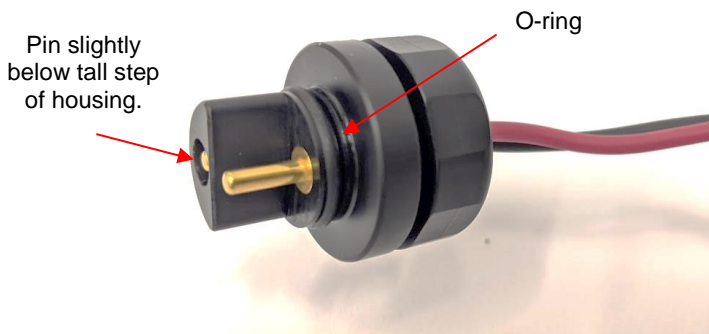

## Section 5: System Troubleshooting



**DO NOT OPERATE THE GEOSUB 2 CONTROLLER IF IT HAS BEEN DAMAGED, BROKEN, SMASHED, OR EXCESSIVELY WORN. BROKEN COMPONENTS POSE A SEVERE THREAT TO THE SAFETY OF THE OPERATOR AND HIS OR HER ENVIRONMENT. CONTACT GEOTECH SERVICE AT 1-800-833-7958 FOR ANY SERVICE OR REPAIR NEEDS.**

Geotech's Geosub 2 Controller has been designed and manufactured to provide a long and trouble-free life under field use conditions. In general, the display will indicate any fault conditions that can occur during use.

**Problem:** The display is not showing anything.

### **Solutions:**

1. Verify the input power is correct and at the correct voltage. If unsure, have a qualified electrician verify main power source.
2. With the unit plugged in to a known good power source, and the pump attached, press the UP button. If the display has simply gone out: Lift the pump out of the well, if you hear a chirp sequence coming from the pump upon start up, followed by the sound of the impeller running, then the display needs to be replaced. Press the main menu key, deploy the pump, and press the UP button again. Run the pump 'blind' using the up and down arrows to control flow. To stop the pump, use the main menu key. Contact Geotech Service to have the display repaired.
3. Disconnect the power cord from both the power outlet and the controller. Visually inspect the cord and plug ends for damage. If damaged, do not use. Visually inspect the power receptacle on the controller, if damaged do not attempt to repair. Contact Geotech Service for repairs.

**Problem:** The display says "NO PUMP ATTACHED"

### **Solutions:**

1. Unplug unit and wait 1-2 minutes, then restart.
2. If pump is submerged under a significant amount of water, program the controller to start at a higher pump speed set point.
3. Inspect the cable for damage and make sure the connections are secure inside the pump. Verify that everything is connected and there is no cable damage.
4. If using preset well settings, increase your pump start up set speed. For example if you had been trying a set speed of 30, try using 50 instead.

**Problem:** The display says “OUTPUT FAULT OVER CURRENT”

**Solutions:**

- Inspect the cable for damage. If no damage is found, disconnect the pump from the controller and press the  button to start the pump. If the display says “OUTPUT FAULT” then the controller is internally damaged and must be returned to Geotech for repairs.
- If the controller display indicates “NO PUMP ATTACHED”, then the problem is in the cable or pump assembly and the controller is working.
- If there is no cable damage then the problem could be in the pump. Use an ohmmeter to measure the input terminals to the pump. If the measurement is less than 100 ohms the potted control board inside the pump must be returned to Geotech Service for repair or replacement. If the measurement is greater than 100 ohms then inspect the motor assembly for bad bearings or debris preventing the impeller from turning.

**Problem:** Pump impeller will not turn and controller indicates “NO PUMP ATTACHED”

**Solutions:**

- If mud, dirt, or sand has dried onto the impeller, soak in water and try to remove debris. If the impeller is free of such debris then one of the bearings may be worn out and you must replace the motor/impeller assembly Geotech Part Number 51200089 (200’ Motor Lead model).
- Check for quality lead connections along entire system assembly. Inspect and repair the 2-pin connections from Controller to Reel and from Reel to Pump.

If you are experiencing other problems than mentioned above, please call Geotech Technical Support for immediate assistance, (800) 833-7958.

## Section 6: System Specifications

Geotech has taken steps to remove all polyflouroalkyl substances (PFAS) materials from the Geosub 2.

### Controller specifications

<b>Model:</b>	Watt Geosub 2 Controller
IP rating:	IP51 when open and operating IP67 when closed. ATA300



Maximum Input power 81200034:	100-130 Volts AC 4.2 amps nominal full load 115 Volts AC 50/60 HZ 310 Watts
Maximum Input power 81200035:	200-250 Volts AC 2.1 amps nominal full load 230 Volts AC 50/60 HZ 300 Watts



**Controllers must be configured for either 110 or 230 Volts AC input at the factory. One or the other input voltages - not both!**

<b>Output power:</b>	Variable 0 to 46 Volts DC at < 300 Watts
Output power @ max voltage:	10 amps (max)
Operating Temp:	-20 to 100° Fahrenheit (-29 to 38°C) (Ambient air temperature)
Humidity:	Up to 90% humidity
Weight:	16.45 lbs. (7.46kg)
Size:	16"L x 13"W x 7"H (41cmL x 33cmW x 18cmH)
Input protection:	5A CB

### Pump specifications

<u>Electric:</u>	
Full Load Rating	2/3 HP
Maximum Amp Draw	10 amps
Overload	Incorporated into Geosub 2 controller

## Pipe Connection

Discharge Port: 1/4" female NPT  
(includes 3/8" hose barb)

## Operating Conditions

Minimum Ambient Fluid Temperature 34°F (1°C)  
Maximum Ambient Fluid Temperature 176°F (80°C)

## Dimensions & Weight (Pump & Motor)

Dimensions of pump 13.2" L X 1.75" OD (34cmL x 4.5cmOD)  
Net Weight of pump w/o lead 4 lbs. (1.8kg)

Weight of small Georeel with the following:

100 feet (30.5m) of 12 AWG & safety cable 18.3 lbs. (8.3kg)  
150 feet (46m) of 12 AWG & safety cable 21.6 lbs. (9.8kg)  
200 feet (61m) of 12 AWG & safety cable 24.9 lbs. (11.3kg)

## Generators

A grounding rod or stake driven directly into moist earth must be installed and electrically connected if using a portable generator larger than 2000 Watts.

### EU1000i

A/C Output 120V  
1000W max. (8.3A)  
900W rated (7.5A)  
D/C Output 12V, 96W (8A)  
Receptacles 15A 125V Duplex  
NEMA Plug: 5-15P  
Weight (Lbs.) 29.0 (empty)  
33.2 (with fuel and oil)  
Dimensions 15.0 x 9.4 x 17.7 – Generator only  
20 x 13.75 x 23 – Generator and Legs

EU2000i

A/C Output	120V 2000W max. (16.7A) 16000W rated (13.3A)
D/C Output	12V, 96W (8A)
Receptacles	20A 125V Duplex NEMA Plug: 5-20P
Weight (Lbs.)	46.3 (empty) 53.8 (with fuel and oil)
Dimensions	20.1 x 11.4 x 16.7 – Generator only 21 x 14.75 x 27 - Generator and Legs



## Section 7: Replacement Parts List

<b>Controller and Reel Replacement Parts</b>	
<b>Part Description</b>	<b>Part Number</b>
MANUAL,GEOSUB 2 CONTROLLER	21200302
GEOSUB CONTROLLER,CE,120V,300W DC OUTPUT	81200034
GEOSUB CONTROLLER,CE,230V,300W DC OUTPUT	81200035
GEOSUB CONTROLLER, CE, 120V HARDWIRE, NO PLUG	81200036
GEOSUB CONTROLLER, CE, 230V HARDWIRE, NO PLUG	81200037
CORD,POWER,6'7"	12070014
CORD,POWER,230V,6'	11200850
FUSE,ATC BLADE TYPE, 15A	11201051
CONNECTOR,FEM,2PIN LARGE GEOSUB CONTROLLER	11201042
CONNECTOR,MALE,2PIN,LARGE GEOSUB REEL	11201043
ASSY,EXTENSION CORD FOR GEOSUB 15 FT	51201004
CABLE,12/2AWG,HDPE,SS,GEOSUB 2, W/ SS SAFETY CABLE	21200176
GEOTECH,DC TO AC INVERTER,600W	81400127
GEOREEL,HAND,GEOSUB 2,100', CE	81400300
GEOREEL,HAND,GEOSUB 2,150' CE	81400301
GEOREEL,HAND,GEOSUB 2,200' CE	81400302

### Accessories:

GUIDE,TAPE,DELTRIN	22050255
CASE,INVERTER,11x16x5",W/FOAM	17500220
PUMP,HOLDER,GEOSUB / RF2	52050284

<b>Geosub 2 Replacement Parts</b>		
<b>Item</b>	<b>Part Description</b>	<b>Part Number</b>
Standard Pump (see Figure 7-1):		
1	BOLT,SS6,10-24x2",EYE W/NUT	17500406
2	HOSEBARB,SS6,3/8 X 1/4 MPT*	17200357
3	CAP,SS6,TOP,GEOSUB 2	21200076
4a	CAP,SS6,O-RINGS,GEOSUB 2	21200121
4b	SCREW, SS8, 6-32 X 3/8 SHCS	(3x) 12070039
5a	KIT,CONNECTOR,COMP,GEOSUB 2,FEMALE GOLD PINS,FOR LEAD	51200307
5b	KIT,CONNECTOR,COMP,GEOSUB 2, MALE GOLD PINS,FOR MODULE	51200308
6	HOUSING,INNER,SS6,GEOSUB	21200072
7	CONTROL MODULE,GEOSUB 2	51200302
8	MOTOR/IMPELLER, GEOSUB 2, 200'	51200300
9	ASSY,MOTOR/CONTROL MODULE,200',GEOSUB 2	51200303
10a	HOUSING,OUTER,GEOSUB 2,SS6	51200298
10b	SCREEN,INTAKE,1.66,SS6	21150095
10c	DISC,SS,1.66	21150148
10d	RING,SNAP,SS6,INTERNAL,1.66	11150051
1-10	PUMP,GEOSUB 2,200',NO LEAD	51200304
Drop Tube Configuration:		
11	HOUSING,DROP TUBE,GEOSUB 2,SS6, DT=HB:0.5 INCLUDED	51200299
12	TUBING,PE,1/2 X 5/8,FT POLYETHYLENE	87050504
13	ASSY,INTAKE,1.66,DROP TUBE	51150071
1-8,11-13	ASSY,PUMP,GEOSUB 2 200',DROP TUBE, NO LEAD	51200305
18	HOSEBARB,SS6,1/2X3/8"MPT	16600217
19	INTAKE, DROP TUBE, 1.66	51150078
O-Ring Details (see Figure 7-2):		
14	O-RING,BUNA,#29,1/16"	(1x) 11201370
15	O-RING,BUNA-N,1.5mmx33mm	(4x) 11201372
16	O-RING,BUNA-N,3.3mmx2.4mm	(2x) 11201371
17	O-RING,#014,BUNA-N	11154057
14-17	O-RING KIT,GEOSUB 2	51200306

Not shown:

CHECK VALVE,GEOSUB 2,1/4"NPT **	81200033
---------------------------------	----------

\* Hose barbs also available in 1/4" and 1/2" tube O.D.

\*\*Check valve (Part # 81200033) installed in place of item #2

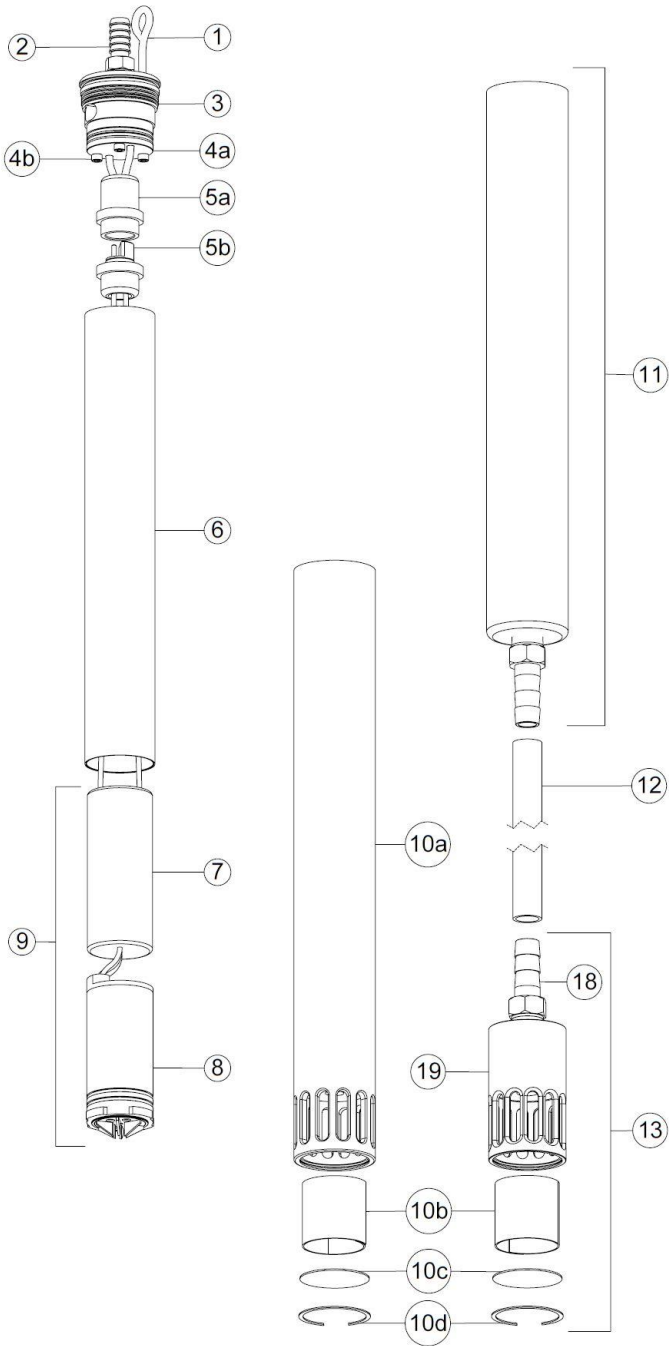

**Figure 7-1: Geosub 2 Pump and Drop Tube Assembly**

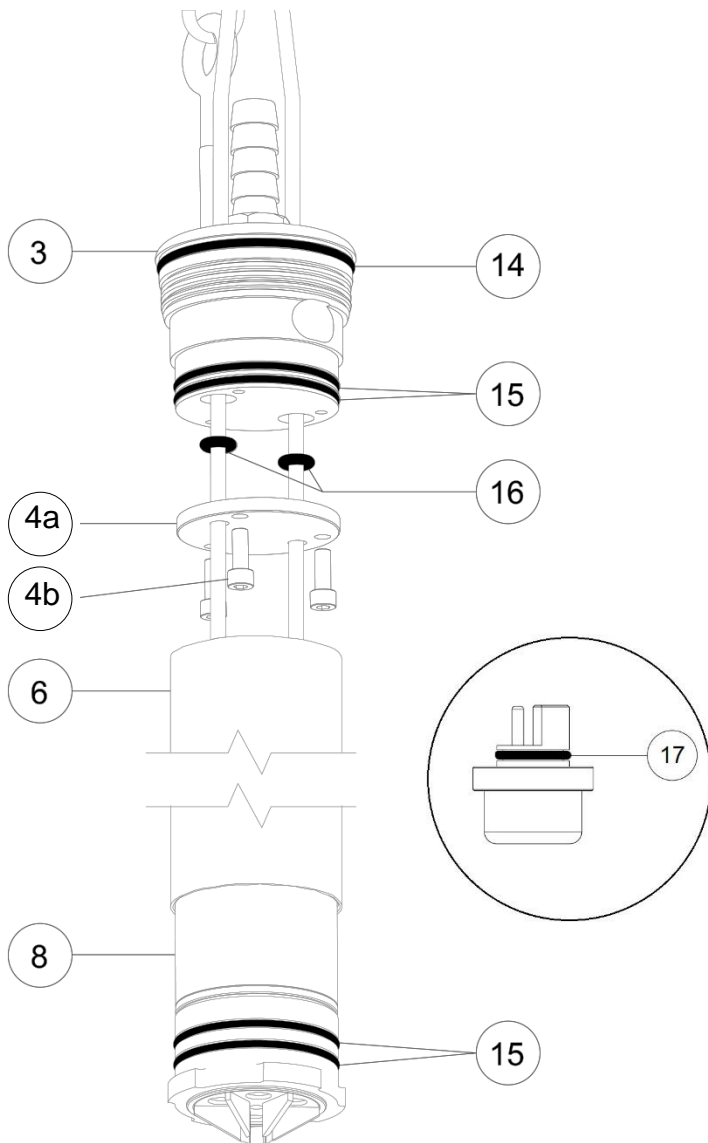

**Figure 7-2: Geosub 2 Pump, O-Ring Diagram**

To replace the two wire lead o-rings (item #16 in Figure 7-2), remove the three socket head cap screws (item #4a) and dislodge the o-ring plate (item #4). The connector on the pump end (item #5a in Figure 7-1) must be removed in order to slide the o-rings and plate off the wire leads. Once the o-rings are replaced and the cap reassembled, the connector must be reinstalled as per *Section 4: System Maintenance*.

## DOCUMENT REVISIONS

PROJECT #	DESCRIPTION	DATE
1690	Release for Geosub 2. SS Geosub information can be found in manual 11200813 - StellaR	11/11/2020
1690	Updated part number list, updated typos - StellaR	11/23/2020

## EC Declaration of Conformity

Manufacturer:

Geotech Environmental Equipment, Inc.  
2650 E 40th Avenue  
Denver, CO 80205

Declares that the following products,

Product Name:

Geosub 2 Pump & Controller

Model(s):

Geosub 2 Pump  
Geosub 2 Controller 120V  
Geosub 2 Controller 230V

Conform to the principle safety objectives of 2006/95/EC Low Voltage Directive by application of the following standards:

EN 61010-1: 2010  
EN 809-1+A1:2010

Year of affixation of the CE Marking: 2010

Conform to the protection requirements of 2004/108/EC Electromagnetic Compatibility (EMC) by application of the following standards:

EN 61000-6-1: 2007  
EN 61000-6-3: 2012  
EN 61326-1: 2013

EMC conformity established 3/3/2010.

Production control follows the ISO 9001:2015 regulations and includes required safety routine tests.

This declaration issued under the sole responsibility of Geotech Environmental Equipment, Inc.

A handwritten signature in cursive script that reads "Joseph Leonard".

Joe Leonard  
Product Development

Serial number \_\_\_\_\_

## The Warranty

For a period of one (1) year from date of first sale, product is warranted to be free from defects in materials and workmanship. Geotech agrees to repair or replace, at Geotech's option, the portion proving defective, or at our option to refund the purchase price thereof. Geotech will have no warranty obligation if the product is subjected to abnormal operating conditions, accident, abuse, misuse, unauthorized modification, alteration, repair, or replacement of wear parts. User assumes all other risk, if any, including the risk of injury, loss, or damage, direct or consequential, arising out of the use, misuse, or inability to use this product. User agrees to use, maintain and install product in accordance with recommendations and instructions. User is responsible for transportation charges connected to the repair or replacement of product under this warranty.

## Equipment Return Policy

A Return Material Authorization number (RMA #) is required prior to return of any equipment to our facilities, please call our 800 number for appropriate location. An RMA # will be issued upon receipt of your request to return equipment, which should include reasons for the return. Your return shipment to us must have this RMA # clearly marked on the outside of the package. Proof of date of purchase is required for processing of all warranty requests.

This policy applies to both equipment sales and repair orders.

FOR A RETURN MATERIAL AUTHORIZATION, PLEASE CALL OUR  
SERVICE DEPARTMENT AT 1-800-833-7958.

Model Number: \_\_\_\_\_

Serial Number: \_\_\_\_\_

Date of Purchase: \_\_\_\_\_

## Equipment Decontamination

Prior to return, all equipment must be thoroughly cleaned and decontaminated. Please make note on RMA form, the use of equipment, contaminants equipment was exposed to, and decontamination solutions/methods used. Geotech reserves the right to refuse any equipment not properly decontaminated. Geotech may also choose to decontaminate the equipment for a fee, which will be applied to the repair order invoice.



**Geotech Environmental Equipment, Inc.**

2650 East 40th Avenue Denver, Colorado 80205  
(303) 320-4764 • (800) 833-7958 • FAX (303) 322-7242

email: [sales@geotechenv.com](mailto:sales@geotechenv.com)

website: [www.geotechenv.com](http://www.geotechenv.com)

**In the EU**

Geotech Equipos Ambientales

Calle Francesc I Ferrer, Guardia Local 19, Mollet del Valles, Barcelona 08100, España

Tlf: (34)93 5445937

email: [ventas@geotechenv.com](mailto:ventas@geotechenv.com)

website: <http://spanish.geotechenv.com>

Printed in the United States of America